



# Operator's Manual

**CC1800XL Concrete Saw**

**Part Number: 1801038**

**(800) 321-5336**

*[www.diamondproducts.com](http://www.diamondproducts.com)*



# Table of Contents

Safety Precautions .....	1	Transmission Lever .....	16
Safety Alerts .....	1	Engaging the Transmission .....	17
Proposition 65 .....	1	Disengaging the Transmission.....	17
Spark Arrester Requirement.....	1	Fuel System (Gas Model).....	17
Respiratory Hazards .....	1	Fueling the Saw .....	17
General Safety .....	2	Fuel Shutoff Valve.....	17
Battery and Electrical Safety .....	2	Storage .....	17
Blade Safety .....	3	Engine/Motor .....	17
Blade Guard Safety.....	3	Engine Governor (Gas Model).....	17
Fuel Safety .....	3	Tasks Prior to Starting the Engine/Motor .....	18
Engine/Motor Safety.....	3	Starting the Engine/Motor .....	18
Cutting Safety .....	4	Stopping the Engine/Motor.....	18
Hydraulic Safety .....	4	Concrete Cutting .....	19
Belt Safety .....	4	Helpful Hints Prior to Cutting.....	19
Transporting Safety.....	4	Tasks Prior to Cutting.....	19
Lifting Safety.....	5	Making a Cut .....	19
Introducing the CC1800XL.....	7	Continuing a Partial-Cut .....	19
Components .....	7	Finishing a Cut.....	19
Controls .....	8	Brake .....	20
Dimensions.....	9	Weight Bars .....	20
Specifications .....	10	Maintaining the CC1800XL .....	21
Operating the CC1800XL.....	11	Maintenance Overview .....	21
Handlebars .....	11	Daily/Regularly .....	21
Adjusting the Handlebars .....	11	125 Hours.....	21
Front Pointer.....	11	Annually.....	21
Adjusting the Front Pointer.....	11	Handlebars .....	21
Battery (Gas Model).....	12	Part Lubrication .....	21
Master Disconnect.....	12	Blade Shaft .....	21
Diamond Blades .....	12	Axle .....	21
Inspecting the Blade .....	12	Drive Shaft .....	21
Blade Speed .....	12	Adjustment Shaft .....	21
Wrench.....	12	Hydraulic Motor .....	22
Installing the Blade .....	13	Inner Blade Flange.....	22
Removing the Blade .....	14	Installing the Inner Blade Flange .....	22
Blade Guard .....	14	Removing the Inner Blade Flange .....	22
Installing the Blade Guard .....	14	Wheels.....	22
Removing the Blade Guard .....	15	Front Wheels .....	22
Flange Guard .....	15	Rear Wheels.....	22
Installing the Flange Guard .....	15	Battery (Gas Model) .....	23
Removing the Flange Guard .....	15	Battery Type .....	23
Water System.....	15	Servicing the Battery .....	23
Water Valve and Supply Hose(s).....	15	Electrical System.....	23
Moving the Water Valve .....	15	Hydraulic Ball Valve (Hydraulic Model).....	24
Water Pump .....	16	Disconnecting the Hydraulic Ball Valve .....	24
Water Tank.....	16	Connecting the Hydraulic Ball Valve .....	24
Handwheel.....	16	Speed Control Lever .....	24
Raising the Saw.....	16	Adjusting the Speed Control Lever .....	24
Lowering the Saw .....	16	Transmission .....	25
Speed Control Lever .....	16	Adding Transmission Oil .....	25
Forward Control .....	16	Adjusting the Drive Wheels.....	25
Reverse Control.....	16	Adjusting the Rear Drive Chain .....	25
Neutral Control.....	16	Belts.....	25

Tensioning the Blade Drive Belts .....	26
Replacing the Blade Drive Belts .....	26
Replacing the Transmission V-Belt .....	26
Engine/Motor .....	27
Cleaning the Engine/Motor.....	27
Fuel Filter (GX620 Honda).....	27
Replacing the Fuel Filter.....	27
Storing .....	27
Disposal .....	28
References .....	29
Appendix A.....	29
Serial Tags.....	29
Appendix B.....	30
Daily Maintenance Task Chart.....	30
Appendix C .....	31
Belt Tension Settings.....	31
Appendix D .....	32
Troubleshooting .....	32
Appendix E.....	33
Additional Resources .....	33

# Safety Precautions

Operate the CC1800XL and all of its components according to this manual. Failure to comply with and understand the following safety, operations, and maintenance instructions can result in serious injuries and/or death. All operators must be properly trained or supervised by experienced personnel prior to using this saw and should understand the risks and hazards involved. Diamond Products discourages improper or unintended saw usage and cannot be held liable for any resulting damages.

Saw modifications should be made by Diamond Products to ensure safety and design. Any modifications made by the owner(s) are not the responsibility of Diamond Products and void all saw warranties if a problem arises as a result of the modification.

Refer to the CC1800XL Parts List for additional information and part diagrams. Refer to the engine/motor manual and manufacturer as the primary source for all safety, operations, and maintenance instructions regarding the engine/motor. Prior to operating, record the saw's serial number, and the engine's/motor's model and serial numbers in Appendix A.

**Notice: The information in this manual may be updated at any time!**

## Safety Alerts

### **DANGER**

Serious injuries and/or death will occur if these instructions are not followed.

### **WARNING**

Serious injuries and/or death could occur if these instructions are not followed.

### **CAUTION**

Mild and/or moderate injuries could occur if these instructions are not followed.

## Proposition 65

### **WARNING**

Engine exhaust and some of its constituents are known to the State of California to cause cancer, birth defects, and/or other reproductive harm.



## Spark Arrester Requirement

### **WARNING**

In the State of California it is a violation of Section 4442 or 4443 to use or operate the engine on any forest-covered, brush-covered, or grass-covered land unless the engine is equipped with a spark arrester, as defined in Section 4442, maintained in effective, working order or the engine is constructed, equipped, and maintained for the prevention of fire pursuant to Section 4443.

## Respiratory Hazards

### **WARNING**

Concrete cutting produces dust and fumes known to cause illness, death, cancer, respiratory disease, birth defects, and/or other reproductive harm. Safety protection techniques include, but are not limited to:

- Wearing gloves.
- Wearing safety goggles or a face shield.
- Using approved respirators.
- Washing work clothes daily.
- Using water when wet cutting to suppress dust.
- Washing the hands and face prior to eating/drinking.

For additional safety and self-protection information contact your employer, the Occupational Safety and Health Administration (OSHA), and/or The National Institute for Occupational Safety and Health (NIOSH).



## General Safety

- Read and understand all of the safety, operations, and maintenance instructions provided in this manual prior to operating or servicing the saw.
- Keep saw components clean and free of slurry, concrete dust, and debris.
- Inspect water hoses prior to operating the saw. Clean, repair, or replace damaged components.
- Raise the saw to a proper height for access when working underneath the saw. Use chocks to block the wheels, and fit blocks or jacks under the frame edges at the front and back of the frame for additional support. 
- When using a jack to raise the saw, place the jack against a solid, flat area under the frame base to properly support the saw while lifting.
- Repair the saw immediately when a problem arises.
- Replace saw decals if unreadable.
- Dispose of all hazardous waste materials according to city, state, and federal regulations.
- Always have a phone nearby, and locate the nearest fire extinguisher and first aid kit prior to operating the saw.
- Operate the saw wearing flame resistant clothing.
- Always wear safety glasses when removing retaining rings.
- Persons under the statutory age limit should not operate the saw.
- Keep all body parts away from rotating machinery.
- Replace all guards and access panels (unless stated otherwise) prior to operating the saw.
- Always pivot guards fully to avoid serious injuries.
- DO NOT assume the saw will remain still when in *Neutral* or when parking/stopping the saw on a slope. Chock the tires to help prevent unnecessary movement.
- Always disconnect electric motor saws from the power source prior to servicing.

### DO NOT:

- Drop equipment, supplies, tools, etc., when handling to help prevent injuries.
- Lift and carry equipment, supplies, tools, etc., that are too heavy and/or cannot be lifted easily.

- Operate the saw without using the appropriate safety equipment required for the work task.



- Operate or service the saw with clothing, hair, or accessories that can snag in the machinery, which could lead to serious injuries or death!

### DO NOT (cont.):

- Operate the saw using attachments not associated with or recommended for the saw.
- Operate the saw around combustible materials or fumes to prevent fires/explosions.
- Operate the saw with anyone near the work area or within the direct line of the blade.
- Operate the saw until all unnecessary materials have been removed from the work area.
- Operate the saw with loose nuts, screws, and bolts.
- Operate the saw when ill or fatigued.
- Operate the saw under the influence of drugs and/or alcohol.
- Operate the saw on steep slopes.
- Cut concrete with guards and access panels removed.
- Grease the saw with the engine/motor running (unless stated otherwise).
- Touch hot components when operating the saw.
- Leave the saw unattended until the engine/motor is off and the blade has stopped spinning.
- Place the saw into storage until it has cooled down.
- Service the saw until it has cooled down.
- Service the saw with the engine/motor running (unless stated otherwise).

## Battery and Electrical Safety

- Ignitable explosive gases are emitted from the battery. DO NOT expose the battery to sparks or open flames. 
- Keep the area around the battery well-ventilated.
- Keep the battery level when handling it.
- Use protective eyewear or a face shield, and avoid contact with the skin when handling/servicing the battery.
- Use a proper battery tester when testing the battery strength.
- Always be sure to connect the battery cables to the proper terminal when reconnecting the cables.
- Occasionally inspect the battery, cables, clamps, and terminals for damages. Service components as necessary.
- Always keep the battery cable clamps away from the battery terminals when the battery is disconnected to avoid accidental connections while servicing.
- Immediately rinse your clothing, skin, or eyes with water if exposed to battery acid. Seek medical attention immediately!
- Disconnect the battery prior to servicing all saw components (unless stated otherwise).
- Remove the battery when storing the saw for longer periods.

- Always use the correct size fuses (amps) to prevent fires.

### **Blade Safety**

- Always use reinforced abrasive blades or steel-centered diamond blades.
  - Never use a wet cutting blade without an adequate water supply to properly lubricate the blade.
  - Inspect all blades prior to usage and discard damaged blades. Clean dirty blades as necessary.
  - DO NOT install or remove a blade with the engine/motor running.
  - Keep all body parts away from rotating blades.
  - Inspect the blade flanges for damages, wear, and cleanliness. Clean or replace dirty/damaged components immediately.
- 
- DO NOT expose yourself or anyone else to the direct line of the blade when operating the saw. 
- 
- Always use an appropriate size blade and the correct blade type based on the cutting task and the type of material being cut.
  - The blade must always fit snug on the blade shaft and/or outer flange.
  - Wear gloves and be alert to the surrounding environment when handling blades.
  - When installing the blade, always point the arrow printed on the blade in the direction of the blade shaft's rotation.
  - DO NOT exceed the blade's maximum recommended speed when cutting. Excessive blade speeds can cause blade breakage, resulting in serious injuries and/or death!
  - DO NOT use damaged blades when cutting to avoid harming yourself, others, or the saw.
  - DO NOT use a blade for cutting that requires a lower speed than the blade shaft speed.
  - Tighten the blade shaft screw/nut as directed to properly secure the outer flange and blade. Failure to properly secure the outer flange and blade may cause parts to loosen or fall off the saw.
  - Let the blade cool prior to removal when dry cutting (applicable models).

### **Blade Guard Safety**

- DO NOT operate the saw with the blade guard raised or removed.
- Blade exposure should not exceed 180° while cutting.
- When pivoting the front of the blade guard, raise/lower it cautiously and slowly to avoid serious injuries.

- Always pivot the front of the blade guard 180° (fully upward) so the guard does not swing down unexpectedly, causing serious injuries. 

- DO NOT install or remove the blade guard with the engine/motor running.
- Always use a blade guard that corresponds with the blade size.
- Inspect the blade guard and water tubes prior to starting the saw. Clean or replace dirty/damaged components immediately.



### **Fuel Safety**

- Always use caution when refueling.
  - Store all fuel in appropriate safety containers.
  - DO NOT operate the saw with a fuel leak.
  - DO NOT fuel the saw with the engine running.
  - Let the engine cool prior to adding fuel.
  - Refer to the engine manual for recommended fuels.
  - Always use appropriate fuels in cold weather.
  - Move the saw away from the refueling area prior to starting the engine.
- 
- DO NOT smoke or expose fuel to open flames when filling the fuel tank or working with fuel. 
- 
- Clean up any spilled fuel prior to starting the engine.
  - Drain the fuel tank and fuel lines when storing the saw for longer periods of time. Refer to the engine manual for additional recommendations.
  - Fuel may seep out from the fuel cap vent (applicable models) when raising the saw if the fuel tank has been overfilled.

### **Engine/Motor Safety**

- Refer to the engine/motor manual as the primary source for engine/motor safety.
  - Always know how to turn off the engine/motor quickly for emergency purposes.
  - Make sure the speed control lever (applicable models) is at *Neutral* when starting the engine/motor.
  - Fill the fuel tank and check the oil level prior to starting the engine.
- 
- Keep all body parts away from rotating saw parts with the engine/motor running. 
- 
- DO NOT start the engine without the air filter(s) installed.
  - DO NOT allow dust to enter the air intake tube when cleaning/replacing air filter(s).
  - Replace damaged components immediately that may allow dust to enter the engine.



- DO NOT leave the engine/motor running unattended.
- Always operate the saw in well-ventilated areas. Concentrated engine exhaust can cause loss of consciousness and/or death. 
- DO NOT touch the engine/muffler assembly with the engine running, and always let them cool down prior to touching or servicing the saw.
- Handle hot oil carefully when changing the oil.
- Wipe down the engine/motor exterior and guards daily or regularly to prevent high operating temperatures. DO NOT spray the engine/motor with water to prevent engine/motor damage.
- Let the engine cool prior to removing pressurized caps (applicable models). 
- DO NOT use any starter substances or starter fluids (e.g., starter fluid sprayed into the air filter) when starting the engine using a glow plug (applicable models). These materials are extremely flammable and explosive, and can melt parts or possibly explode when used to help start the engine.
- All electric motor saws should be properly grounded prior to operating.
- DO NOT supply less or more power to the electric motor saw than what the motor is rated for.
- DO NOT use a hydraulic power unit that supplies less power to the hydraulic motor saw than required.

### Cutting Safety

- The direct work area should not contain buried or embedded electrical, gas, or water lines that could be damaged and/or cause personal injury while cutting.
- Turn off all electricity, gas, and water around the direct work area prior to cutting.
- DO NOT expose yourself or anyone else to the direct line of the blade when operating the saw. 
- DO NOT allow any person, animal, and/or object in and around the work area while cutting.
- When using an electric motor saw, be aware of all active electrical lines if using power from the direct work area to operate the saw.

### Hydraulic Safety

- DO NOT disconnect hydraulic hoses when the saw is running.

- Always place a piece of cardboard or paper up against hydraulic components, or use a leak detection fluid to check for hydraulic fluid leaks. Keep all body parts away from leaks and/or areas that may eject hydraulic fluid. Pressurized hydraulic fluid can penetrate the skin, causing serious injuries. Seek medical attention immediately! 

### Belt Safety

- Turn off the engine/motor and let the belts cool down prior to servicing them.
- Regularly inspect the belts for fraying, stress cracks, and/or breakage and replace immediately when damaged. Always check belt alignment prior to operating the saw.
- Over-tensioning the belts may damage the engine crankshaft. Under-tensioning the belts may cause slippage, shorter belt life, and/or poor saw performance.
- Squealing belts indicate looseness.
- DO NOT use old and new belts on the same sheave together.

### Transporting Safety

- Remove the blade prior to transporting the saw.
- Make sure the truck/trailer is in good, working condition and sufficient to transport the load. DO NOT tow the saw behind a vehicle.
- Close the fuel shutoff valve when transporting.
- Drain the fuel tank when transporting long distances.
- Use heavy-duty ramps that will support the weight of the saw and yourself when loading or unloading.
- Raise the saw to avoid damaging components while moving up and down ramps.
- Use extreme caution when guiding the saw up and down ramps. Slowly drive/push the saw forward down the ramp. Slowly back/pull the saw in reverse up the ramp. Avoid standing directly downhill from the saw to avoid serious injuries. 
- Chock the wheels and secure the saw in a truck/trailer prior to transporting.
- Turn off the engine/motor once the saw is loaded into the truck/trailer. For self-propelled models, place the speed control lever at *Neutral* and engage the transmission prior to turning off the engine.
- Engage the brake once the saw is secure in the truck/trailer to help secure.
- Refer to the Department of Transportation (DOT) for additional transporting recommendations.

## ***Lifting Safety***

---

- Move yourself and all others away from the lifting area when hoisting the saw to prevent being crushed.
- Secure the appropriate hoisting cables, straps, and/or chains to the saw's designated lift points prior to hoisting.
- DO NOT attempt to lift the saw irresponsibly and/or improperly.





# Introducing the CC1800XL

## Components

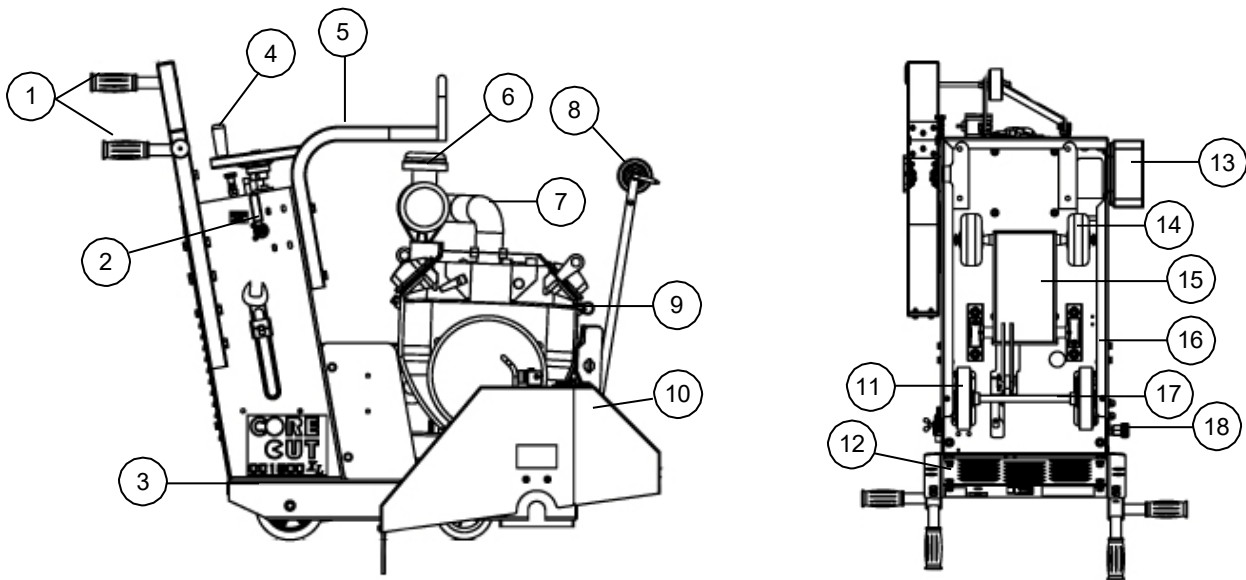

Figure 1: CC1800XL Components

1. Handlebars
2. Water Valve
3. Frame
4. Handwheel
5. Lift Bar
6. Air Cleaner
7. Air Intake
8. Front Pointer
9. Engine

10. Blade Guard
11. Rear Wheels
12. Instrument Panel
13. Flange Guard
14. Front Wheels
15. Front Axle
16. Belt Guard
17. Rear Axle
18. Water Supply Fitting

## Controls



Figure 2: Control Panel (Gas Model)

### Controls Shown Above:

1. **Fuel Tank Cap**—Opening to add fuel; indicates fuel level (tank located above engine on certain models).
2. **Tachometer/Hour Meter**—Indicates engine speed and total number of saw hours operated.
3. **Transmission Lever**—Engages/disengages transmission.
4. **Master Disconnect**—Connects/disconnects battery circuit.
5. **Water Pump Switch (optional item)**—Pumps water to blade.
6. **Throttle Lever**—Increases/decreases engine speed.
7. **Speed Control Lever (self-propelled model)**—Controls forward/neutral/reverse motion of saw.
8. **Index Plunger**—Locks/unlocks handwheel.
9. **Ignition Switch**—Starts engine.
10. **Water Valve**—Controls water flow to blade.
11. **Choke**—Restricts air flow in carburetor when starting a cold engine (choke located on engine on certain models).
12. **Handwheel**—Raises/lowers saw and blade.

### Controls not Shown Above:

1. **Engine Switch**—Actuate in order to start/stop engine.
2. **Stop Pushbutton**—Stops engine (engine switch must be off to stop engine permanently).
3. **Recoil Starter**—Starts engine.
4. **Fuel Shutoff Valve/Lever**—Opens/closes fuel line.
5. **Start Pushbutton**—Starts electric motor.
6. **Stop Pushbutton**—Stops electric motor.
7. **Ammeter**—Indicates electric motor's load while cutting.
8. **Hydraulic Ball Valve**—Starts/stops hydraulic motor.

*Note: All controls vary based on saw model.*

## Dimensions

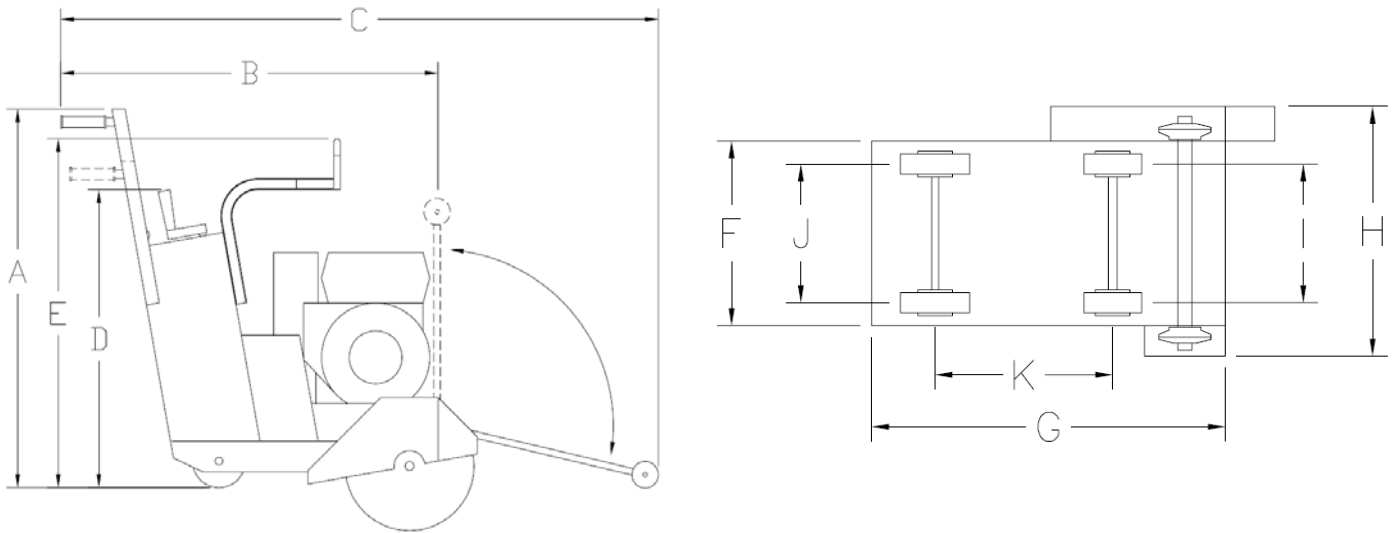

Figure 3: CC1800XL Dimensions

Table 1: CC1800XL Dimensions		
A	Saw Height (Minimum/Maximum)	36"/42"
B	Saw Length (Minimum, Pointer Up, Handle Down)	50"
C	Saw Length (Maximum, Pointer Down, Handle Up)	70"
D	Saw Height to Hand Wheel	36"
E	Saw Height to Lift Bar	40-3/4"
F	Frame Width Rear	16"
G	Frame Length with Weights	33"
H	Frame Width Front	23"
I	Front Axle Center Length	11"
J	Rear Axle Center Length	12"
K	Wheel Base Length	15-1/2"
	Handlebar Width (Handles In)	19-3/8"
	Handlebar Width (Handles Out)	31-1/4"
	Crated Dimensions	54" x 30" x 45"
<i>Dimensions for saw with optional water tank not shown</i>		

## Specifications

<b>Table 2: CC1800XL Specifications</b>	
Maximum Cutting Depth	4-5/8" with 14" blade
Maximum Cutting Depth	7-5/8" with 20" blade
Blade Shaft Diameter	1-1/4"
Blade Shaft RPM	2,600
Arbor Diameter	1" with single alignment pin
Blade Shaft Bearings	Self-aligning pillow block bearings
Blade Shaft Drive	Three or four 3VX V-belts
Blade Mounting	Right or left
Blade Raise/Lower	Screw feed
Blade Coolant	Dual multi-spray water tubes
Blade Guard Attachment	Slip-on up to 20"
Handlebars	Adjustable height and reversible
Transmission	Eaton model 6, or push model
Drive Speed	0-80 ft/min
Electric Start	GX620 Honda only
Fuel Capacity	Two gallons
Tachometer/Hour Meter	Standard on GX620 Honda
Quick Disconnect Blade Flanges	Standard
Frame Lift	Standard
Uncrated Dry Weight	280-415 lb (add 40 lb for crated weight)

<b>Table 3: Engine Specifications</b>			
Manufacturer	Honda	Briggs Vanguard	Honda
Model	GX390	N/A	GX620
Fuel Type	Unleaded gasoline	Unleaded gasoline	Unleaded gasoline
Air Filter	Cyclone	Dual element	Snorkel type, dual element
Low Oil Alert	Standard	Standard	Standard
<i>Note: Refer to the engine manual for additional information.</i>			

<b>Table 4: Electric Motor Specifications</b>	
Manufacturer	Baldor Electric
Phase/Voltage	1PH-230V, 3PH-230V, 3PH-460V, 3PH-575V
<i>Note: Refer to the motor manual for additional motor specifications.</i>	

<b>Table 5: Hydraulic Motor Specifications</b>	
Manufacturer	Danfoss Hydraulic
Displacement (cubic inches (CI)/revolution)	1.16CI, 1.55CI, 1.94CI
<i>Note: Refer to the motor manufacturer for additional motor specifications.</i>	

# Operating the CC1800XL

## Handlebars

The handlebars help the operator guide and maneuver the saw.

### Adjusting the Handlebars

1. Remove the screws securing the handlebar to the frame upright.
2. Holding the handlebar grip, move the handlebar up or down (matching the holes on the handlebar shaft to the holes on the frame upright) to adjust the handlebar to the desired height. Turn the handlebar 90° to change the position if desired. *Note: The handlebar cannot be placed in the lowest position on the hydraulic motor saw because of the location of the hydraulic tubes.*

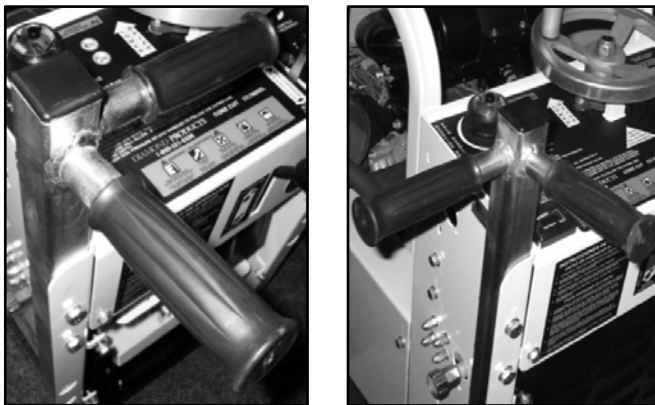

Figure 4: Handlebar Positions

3. Secure the handlebar to the frame upright. Adjust the handlebar height as necessary.
4. Repeat steps 1–3 to adjust the other handlebar.

## Front Pointer

The front pointer helps the operator follow the cutting line.

### Adjusting the Front Pointer

1. Remove the looped end of the shorter pointer rope line from the handlebar grip.
2. Lower the front pointer frame to the ground.
3. Divide an 8–10 ft piece of string in half.

4. Place the looped end of string into a gullet on the backside of the blade.
5. Place one string line up against the backside of the blade and one string line up against the front side of the blade. Holding the string ends in one hand, tension the lines out toward the pointer rod.

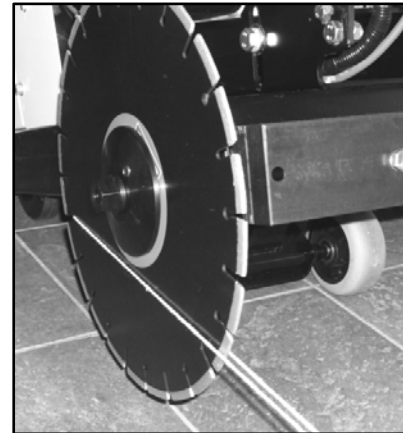

Figure 5: String Line against Blade

6. Loosen the nuts securing the pointer rod.
7. Adjust the pointer rod to place the pointer tip in between the tensioned string lines.

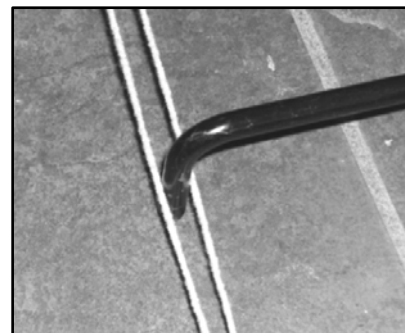

Figure 6: Pointer between Strings

8. Retighten the nuts to secure the pointer rod.
9. Lift the pointer frame off the ground when the cutting task is complete.
10. Place the looped end of the pointer rope around the handlebar grip.



## Battery (Gas Model)

### WARNING

- Ignitable explosive gases are emitted from the battery. DO NOT expose the battery to sparks or open flames, and keep the area around the battery well-ventilated.



### CAUTION

- Use a proper battery tester when testing the battery strength.
- Use protective eyewear or a face shield, and avoid contact with the skin when handling/servicing the battery.



The gasoline saw contains a charged battery with one positive battery cable lead and one negative battery cable lead.

### Master Disconnect

The master disconnect connects or disconnects the battery's circuit. *Note: Make sure the master disconnect is on if the engine does not start.*



**Figure 7: Master Disconnect**

- Turn on the master disconnect to activate the battery, or turn off the master disconnect to deactivate the battery.

## Diamond Blades

### WARNING

- DO NOT exceed the blade's maximum recommended speed when cutting. Excessive blade speeds can cause blade breakage, resulting in serious injuries and/or death!
- DO NOT use damaged blades when cutting to avoid harming yourself, others, or the saw.
- Always use an appropriate size blade and the correct blade type based on the cutting task and the type of material being cut.



Using the proper blade (size and type) preserves the blade and improves cutting and operator efficiency, resulting in lower costs. Refer to the Association of Equipment Manufacturers (AEM) safety brochure for diamond blades or [www.diamondproducts.com](http://www.diamondproducts.com) for additional blade information.

### Inspecting the Blade

Inspect each blade prior to installation and discard all damaged blades. Inspect all blades for:

- Cracks, nicks, and dents
- A damaged and/or deformed arbor (center hole)
- Darkness and/or discoloration near edge of blade
- A deformed blade circumference
- Segment loss and/or segment cracks
- Core wear
- Bending
- Uneven side-widths

### Blade Speed

Refer to the blade packaging information or to the information printed on the blade for the recommended and maximum recommended blade speeds when cutting. DO NOT exceed the maximum recommended cutting speed. DO NOT use a blade that is rated with a lower maximum recommended speed than the blade shaft speed.

### Wrench

Use the wrench when installing or removing a blade. Apply force to the opposite end of the wrench and tighten the blade shaft nut to 50 ft-lb (67.8 Nm) to properly secure the outer flange and blade. This measurement can be verified with a torque wrench.

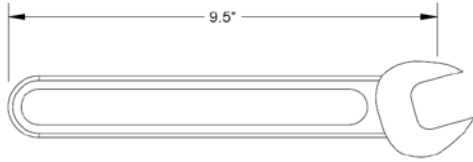

**Figure 8: Wrench**

***Installing the Blade***

**! WARNING**

- DO NOT install a blade with the engine/motor running.
- Failure to properly secure the outer flange and blade may cause parts to loosen or fall off the saw.



**! CAUTION**

- Wear gloves and be alert to the surrounding environment when handling blades.

Install the blade on either the right or left side of the saw; utilize the side most appropriate for the cutting task.

1. Remove the blade guard or pivot the front of the guard 180° (fully upward) to gain access to the blade flanges. *Note: Failure to fully pivot the guard may cause serious injuries.*
2. Remove the blade shaft nut using the wrench. Turn the nut clockwise on the right side of the saw and counterclockwise on the left side of the saw to loosen.



**Figure 9: Blade Flanges and Nut**

3. Carefully pull the outer flange off of the blade shaft and out of the inner flange alignment pinhole.

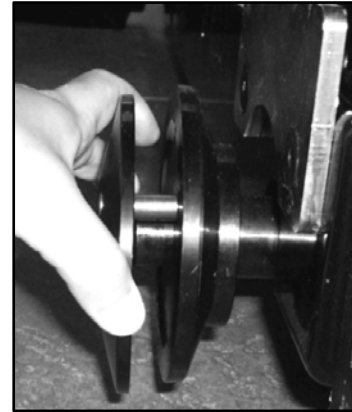

**Figure 10: Separating Flanges**

4. Inspect the nut, outer flange, and inner flange for damages and clean, repair, or replace as necessary.
5. Select the correct blade type and size for the cutting task and inspect the blade for damages. DO NOT use blades that are too small or large for the saw.
6. Raise the saw slightly (for easier access when installing the blade).
7. Place the blade onto the blade shaft (the blade should fit snug on the blade shaft). Always point the arrow printed on the blade in the direction of the blade shaft's rotation.
8. Place the outer flange onto the blade shaft, and align and fit the outer flange alignment pin through the blade's pinhole and into the inner flange alignment pinhole.

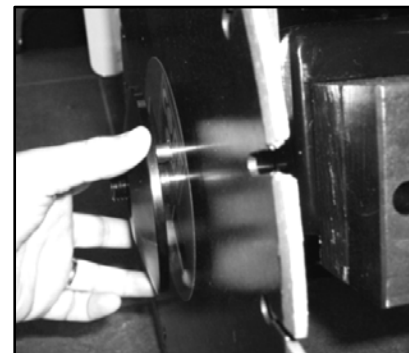

**Figure 11: Inserting Outer Flange**

9. Slightly rotate the outer flange and blade backward to eliminate backlash (looseness) between parts.
10. Fit the blade shaft nut onto the blade shaft and tighten by hand.
11. Slowly lower the blade until it touches the ground.
12. Tighten the nut, using the wrench, to 50 ft-lb (67.8 Nm) to properly secure the outer flange and blade.

This measurement can be verified with a torque wrench.

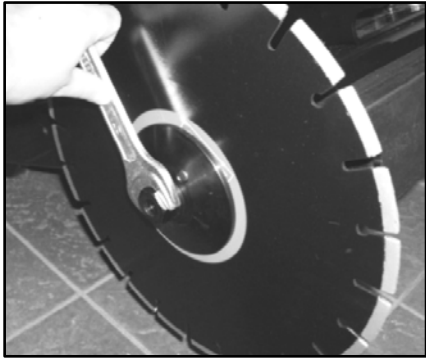

Figure 12: Tightening Nut

13. Replace the blade guard or pivot the front of the guard down and over the blade to secure.

#### Removing the Blade

#### **! CAUTION**

- DO NOT remove a blade with the engine/motor running.

1. Remove the blade guard or pivot the front of the guard 180° (fully upward) to gain access to the blade flanges. *Note: Failure to fully pivot the guard may cause serious injuries.*
2. Slowly lower the blade until it touches the ground.
3. Remove the blade shaft nut using the wrench.
4. Carefully remove the outer flange from the inner flange alignment pinhole and blade, and then remove the flange from the blade shaft.
5. Remove the blade from the blade shaft. Place the blade in an appropriate storage location.
6. Inspect the nut, outer flange, and inner flange for damages and clean, repair, or replace as necessary.
7. Fit the outer flange back onto the blade shaft.
8. Place the blade shaft nut onto the blade shaft and tighten by hand to secure the inner and outer flange together.
9. Replace the blade guard or pivot the front of the guard down and over the blade to secure.

## Blade Guard

### **! WARNING**

- DO NOT operate the saw with the blade guard raised or removed.
- DO NOT install or remove the blade guard with the engine/motor running.
- Blade exposure should not exceed 180° while cutting.
- Always pivot the front of the blade guard 180° (fully upward) so the guard does not swing down unexpectedly, causing serious injuries.



The blade guard shields the blade and must always be in place when operating the saw. Inspect the blade guard and its water tubes prior to starting the saw. Clean, repair, or replace damaged components immediately. *Note: Always use a blade guard that corresponds with the blade size.*

#### Installing the Blade Guard

1. Face the front of the blade guard forward and fit the tapered mount on the side of the guard over the tapered blade guard mount on the frame.



Figure 13: Lowering Guard

2. Connect the water supply hose to the blade guard. *Note: Keep the water hose, when cutting on the left side of the saw, away from the muffler assembly to prevent hose damage.*



**Figure 14: Connecting Water Hose**

### Removing the Blade Guard

1. Disconnect the water supply hose from the blade guard.
2. Use the handle on the blade guard to rock the guard back and forth while lifting the guard off of the tapered mount.

### **Flange Guard**

#### Installing the Flange Guard

1. Fit the tapered mount on the backside of the flange guard over the tapered blade guard mount on the frame.

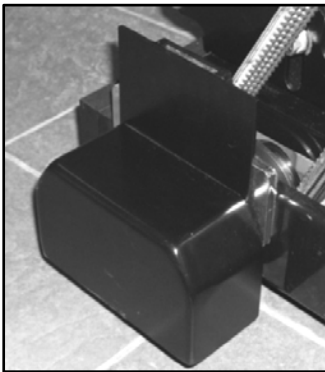

**Figure 15: Flange Guard**

#### Removing the Flange Guard

1. Lift the flange guard off of the tapered blade guard mount.

### **Water System**

The water system cools the blade and suppresses dust when cutting. Keep the water hose, when cutting on the left side of the saw, away from the muffler assembly to prevent hose damage. *Note: Always test the water supply for adequate pressure and flow prior to cutting.*

#### Water Valve and Supply Hose(s)

1. Connect the water source hose to the water supply fitting.

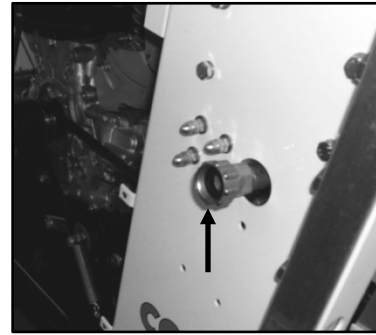

**Figure 16: Water Supply Fitting**

2. Connect the water supply hose to the blade guard. *Note: Disconnect and reconnect the hose when moving the blade guard to the opposite side of the saw.*
3. Turn on the water valve to start the water flow and turn off the water valve to stop the water flow. The water flow between these two points increases/decreases based on the valve's position. *Note: Turn on the water just before cutting to avoid wasting water.*

#### Moving the Water Valve

The water valve can be moved to the left side of the saw if preferred (on models with no fuel tank under the control panel); however, it must be moved to the left side of the saw when the hydraulic valve assembly (hydraulic motor saw) is moved to the right side of the saw.

1. Remove the screws securing the water valve to the frame upright.



**Figure 17: Water Valve Assembly**

2. Remove the water valve from the 1–1/4" plug hole.
3. Fit the water valve through the 1–1/4" plug hole on the opposite side of the saw.
4. Secure the valve to the frame upright.

### Water Pump

The water pump (optional item) pumps water from the water source to the saw as necessary. **DO NOT** leave the water pump on when finished cutting to avoid draining the battery.

1. Turn on the water pump switch to start the pump.
2. Turn off the water pump switch to stop the pump.

### Water Tank

The water tank (optional item) suppresses airborne dust when wet cutting. *Note: The water tank cannot be used with the electric motor saw.*

- Connect the water tank's water supply hose to the blade guard prior to operating the saw.

### **Handwheel**

The handwheel raises and lowers the saw and blade.

*Note: The saw can be raised and lowered with the engine/motor off.*



**Figure 18: Handwheel**

### Raising the Saw

1. Pull out the index plunger and turn it 90° to remove from the plunger groove. Turn the handwheel counterclockwise to raise the saw.
2. Turn the index plunger 90° to lock it back into the plunger groove. Turn the handwheel slightly to lock the handwheel.

### Lowering the Saw

1. Pull out the index plunger and turn it 90° to remove from the plunger groove. Turn the handwheel clockwise to lower the saw.

2. Turn the index plunger 90° to lock it back into the plunger groove. Turn the handwheel slightly to lock the handwheel.

### **Speed Control Lever**

The speed control lever (self-propelled model) places the saw in neutral (no movement), forward, or reverse.

*Note: The engine must be running and the transmission must be engaged to move the saw using the speed control lever.*

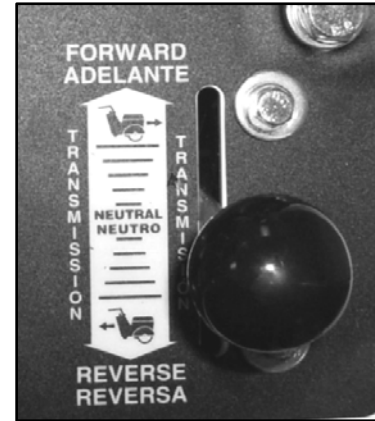

**Figure 19: Speed Control Lever**

### Forward Control

Push the speed control lever forward to reach the proper traveling speed. The maximum speed the saw will move forward, at full throttle, is 80 ft/min.

### Reverse Control

Pull the speed control lever backward to reach the proper traveling speed. The maximum speed the saw will move backward, at full throttle, is 80 ft/min.

### Neutral Control

Place the speed control lever at *Neutral* to stop the saw. **DO NOT** assume at any time that the transmission will act as a brake in neutral.

### **Transmission Lever**

Disengage the transmission (self-propelled model) prior to starting the engine to prevent unnecessary saw movement. The engine must run at half throttle or greater for proper transmission efficiency when maneuvering the saw with power.



**Figure 20: Transmission Lever**

Engaging the Transmission

1. Place the speed control lever at *Neutral*.
2. Start the engine.
3. Pull the transmission engagement lever down to *Engage*.

Disengaging the Transmission

1. Place the speed control lever at *Neutral*.
2. Push the transmission engagement lever up to *Disengage*.

**Fuel System (Gas Model)**

**! WARNING**

- DO NOT operate the saw with a fuel leak.
- DO NOT fuel the saw with the engine running.
- DO NOT smoke or expose fuel to open flames when filling the fuel tank or working with fuel.



**! CAUTION**

- Clean up any spilled fuel prior to starting the engine.

Fueling the Saw

Fill the fuel tank as necessary.

1. Lower the saw so the engine is level.
2. Stop the engine and let the saw cool down.
3. Remove the fuel tank cap.
4. Fill the fuel tank with unleaded gasoline. Refer to the engine manual for refueling information.
5. Replace the fuel tank cap and tighten to secure.

Fuel Shutoff Valve

1. Open the shutoff valve to open the fuel line.
2. Close the shutoff valve to close the fuel line.

Storage

Refer to the engine manual for fuel recommendations when storing the saw.

**Engine/Motor**

Refer to the engine/motor manual as the primary source for information.

**! WARNING**

- DO NOT leave the engine/motor running unattended.
- Always operate the saw in well-ventilated areas. Concentrated engine exhaust can cause loss of consciousness and/or death.
- All electric motor saws should be properly grounded prior to operating.



Engine Governor (Gas Model)

The engine governor (located at the top of the engine) is factory set for an engine speed of 3,600 RPM. DO NOT change this setting to prevent engine damage. Occasionally measure the engine speed and adjust to the factory setting, as necessary, following the steps below:

1. Use a handheld tachometer or other appropriate device to measure the engine speed at the engine crankshaft.
2. Adjust the engine governor to correct the engine speed.



**Figure 21: Engine Governor**

### Tasks Prior to Starting the Engine/Motor

Make sure to complete the following tasks prior to starting the engine/motor:

- Fill all liquids to appropriate levels for proper saw operation.
- Turn off water valve.
- Turn off water pump.
- Set speed control lever at *Neutral* (self-propelled model).
- Disengage transmission (self-propelled model).
- Set engine throttle to slowest position (gas saw).
- Turn off hydraulic ball valve (hydraulic motor saw).
- Remove tools from work area.
- Raise blade off ground.

### Starting the Engine/Motor

#### **Gasoline Engine**

1. Open the fuel shutoff valve or move the fuel shutoff lever to the open or on position.
2. Close the choke. *Note: When restarting a warm engine, open the choke.*
3. Increase the throttle by approximately 1/3 (Honda engine). Increase the throttle to *FAST* (Briggs Vanguard engine).
4. Turn on the engine switch (applicable models).
5. Pull the recoil starter handle backward slowly until resistance is felt, and then pull the handle backward quickly (applicable models). Gently return the handle and repeat if the engine does not start. *Note: Refer to the engine manual for troubleshooting recommendations after several failed attempts.*



**Figure 22: Recoil Starter**

6. Insert the key into the ignition, turn the key to *Start*, and release the key when the engine starts (applicable models). If the engine does not start, release the key and try again shortly. *Note: Refer to the engine manual if the engine does not start after two attempts.*



**Figure 23: Ignition**

7. Decrease the throttle to the slowest position. Gradually open the choke while the engine warms up.
8. Increase the throttle to the fastest position and adjust the throttle as necessary for maximum efficiency. **DO NOT** exceed the maximum recommended cutting speed when operating the saw.

#### **Electric Motor**

1. Plug the saw into an outlet or generator. Refer to Diamond Products for a list of recommended power cord gauges. *Note: DO NOT supply less power or more power, through the power source, to the motor than what the motor is rated for.*
2. Press the start button on the starter box.

#### **Hydraulic Motor**

1. Connect the return hose from the hydraulic power unit to the return line quick disconnect on the saw.
2. Connect the pressure hose from the hydraulic power unit to the pressure line quick disconnect on the saw. *Note: The motor will not start if the hoses are improperly connected.*
3. Turn on the hydraulic power unit.
4. Push the ball valve on the saw down 90° to open the valve and start the motor. Adjust the flow control on the hydraulic power unit to increase/decrease the motor speed. **DO NOT** exceed the maximum recommended blade speed when cutting. **DO NOT** use a hydraulic power unit that will supply less power to the hydraulic motor than required.

### Stopping the Engine/Motor

#### **! WARNING**

- **DO NOT** disconnect hydraulic hoses when the saw is running.



## CAUTION

- DO NOT leave the saw unattended until the engine/motor is off and the blade has stopped spinning.

### **Gasoline Engine**

1. Decrease the throttle to the slowest position for several minutes.
2. Hold down the stop button (on the control panel) to stop the engine (applicable models). *Note: This action does not permanently stop the engine.*
3. Turn off the engine switch (applicable models). *Note: Turning off the switch will stop the engine permanently and will prevent the blade from spinning unexpectedly.*
4. Turn the ignition key to *Off* and remove the key (applicable models).
5. Close the fuel shutoff valve (if desired).

### **Electric Motor**

1. Press the stop button on the starter box.
2. Disconnect the power cord from the saw and from the outlet or generator.

### **Hydraulic Motor**

1. Decrease the hydraulic flow on the hydraulic power unit.
2. Push the ball valve on the saw up 90° to close the valve and stop the motor.
3. Decrease the hydraulic flow to the minimum (or stop position) on the hydraulic power unit.
4. Turn off the hydraulic power unit.
5. Disconnect the hydraulic power unit's pressure hose from the pressure line quick disconnect on the saw.
6. Disconnect the hydraulic power unit's return hose from the return line quick disconnect on the saw.

## **Concrete Cutting**

### WARNING

- DO NOT expose yourself or anyone else to the direct line of the blade when operating the saw.
- Turn off all electricity, gas, and water around the direct work area prior to cutting.
- When using an electric motor saw, be aware of all active electrical lines if using power from the direct work area to operate the saw.



### Helpful Hints Prior to Cutting

Keep the following things in mind for greater efficiency when cutting:

- Use just enough handle pressure to guide the saw on the cutting line. DO NOT forcibly direct (twist) the saw from side-to-side when cutting.
- Avoid sawing excessively deep to preserve the blade and reduce sawing costs.
- Moving too quickly when cutting may stall the saw or may cause the blade to climb out from the cut. If the saw stalls at any time, move the speed control lever to *Neutral* (self-propelled model), raise the blade from the cut, and restart the engine/motor.
- DO NOT lower the blade too quickly or move the saw forward too quickly when finishing a partial-cut to avoid forcing the blade into the concrete.

### Tasks Prior to Cutting

Complete the following tasks prior to cutting:

- Raise the blade to provide proper clearance between the blade and the ground when maneuvering the saw.
- Align pointer assembly with the blade.
- Clearly mark the cutting line.
- Be sure the work area does not contain any buried or embedded electrical, gas, or water lines.

### Making a Cut

1. Turn on the water valve. *Note: Always use a proper water pressure and flow when cutting.*
2. Turn on the water pump (as necessary).
3. Align the blade and front pointer with the cutting line.
4. Lower the blade into the concrete slowly, in two-inch increments, to reach the desired cutting depth. DO NOT cut any deeper than required.
5. Use the speed control lever (self-propelled model) or push (push model) the saw forward, at a proper speed, to continue down the cutting line. Cut as fast as the blade allows; if the blade climbs out of the cut reduce the forward speed and/or cutting depth. Raise and lower the blade as necessary while cutting.

### Continuing a Partial-Cut

1. Align the blade with the previous cut and lower the blade back into the cut. DO NOT move forward unless the blade is properly aligned within the cut.
2. Use the speed control lever (self-propelled model) or push (push model) the saw forward, at a proper speed, to continue down the cutting line. Raise and lower the blade as necessary while cutting.

### Finishing a Cut

1. Place the speed control lever at *Neutral* (self-propelled model), or stop the saw (push model).
2. Raise the blade from the cut (high enough for proper ground clearance).
3. Turn off the water valve.



4. Turn off the water pump.

### **Brake**

The brake (optional item) stops the saw from moving forward or backward unintentionally. DO NOT assume at any time the transmission will act as a brake when at *Neutral*. *Note: On extreme slopes chock the tires to prevent unnecessary saw movement.*

1. Push the brake pedal down and pivot it into the left brake groove (on the frame) to engage the brake.
2. Push the brake pedal down and pivot it into the right brake groove (on the frame) to disengage the brake.

### **Weight Bars**

The weight bars provide additional weight to the front of the saw to improve overall performance. The combined weight is approximately 26 lb.

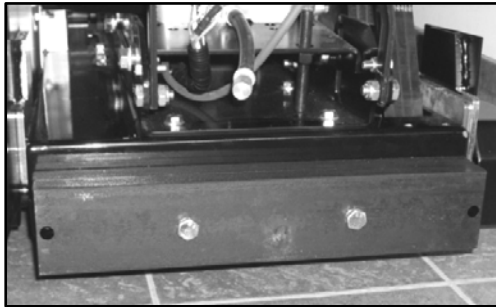

**Figure 24: Weights**

1. Secure the weight bars to the front of the frame base.
2. Remove the screws to remove the weight bars.

# Maintaining the CC1800XL

Failure to read and comply with the maintenance instructions provided in this manual prior to performing maintenance may result in serious injuries and/or death, and may harm the saw. DO NOT attempt to perform maintenance on the saw if you are not properly trained for it, or are not supervised by an experienced person.

Refer to the CC1800XL Parts List for additional information and part diagrams when performing maintenance tasks. Refer to the engine/motor manual and manufacturer as the primary source for all safety, operations, and maintenance instructions for the engine/motor. Contact the saw and/ or engine/motor manufacturers with any additional questions.

Remove all necessary guards and access panels prior to servicing the saw. Replace prior to operating.

## Maintenance Overview

Complete the following tasks as required. DO NOT delay maintenance! Print the Daily Maintenance Task Chart from Appendix B to keep track of the maintenance tasks completed.

### Daily/Regularly

- Lubricate blade shaft bearing grease fittings daily or two to three times daily when dry cutting.
- Inspect belts after first four hours of use, and then daily for tension and wear. Replace or re-tension as necessary.
- Inspect saw for damages.
- Tighten loose nuts and bolts.
- Verify that drive wheels fully engage rear wheels when transmission is engaged (self-propelled model).
- Clean air filter daily or two-to-three times daily when dry cutting (see engine manual).
- Check fuel level and fill as necessary.
- Check engine oil level and fill as necessary (see engine manual).
- Wipe down saw's exterior.
- Wipe down engine's/motor's exterior and guards.
- Look for fluid leaks.
- Re-tension rear drive chain as necessary (self-propelled model).

### 125 Hours

- Replace fuel filter (GX620 Honda).

### Annually

- Inspect the battery, battery cables, and cable connectors and clean.

*Note: Refer to the engine/motor manual and manufacturer for daily engine/motor care and routine maintenance tasks.*

## Handlebars

The handlebars generally require little or no maintenance and, when used correctly, should remain in good condition. Inspect the handlebars occasionally for bending, unusual cracks, and/or breakage. Replace them immediately when damaged.

## Part Lubrication

### **WARNING**

- DO NOT grease parts with the engine/motor running (unless stated otherwise).



Lubricating parts on schedule increases the saw's efficiency and life. Use NLGI No. 2 premium lithium-based grease when lubricating parts. Use one to two full pumps of grease when lubricating grease fittings.

### Blade Shaft

Lubricate both blade shaft bearing grease fittings at the end of the workday, or two to three times daily when dry cutting. Grease the fittings with the engine/motor running at idle (**extremely low speed!**). **Be extremely careful when greasing with the engine/motor running to avoid entanglement.** *Note: If the bearings are too hot to touch after completing work, there is either a lack of grease or the belts are too tight.*

### Axle

Lubricate both pillow block bearing grease fittings every 40 hours of operation. Lubricate both rear wheel grease fittings every 40 hours of operation.

### Drive Shaft

Lubricate both flange block bearing grease fittings every 20 hours of operation.

### Adjustment Shaft

Lubricate the adjustment shaft grease fitting every 40 hours of operation.

### Hydraulic Motor

Lubricate the pillow block grease fitting every 40 hours of operation.

### **Inner Blade Flange**

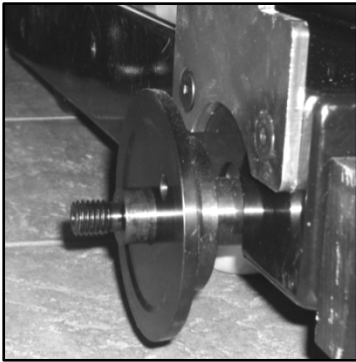

**Figure 25: Inner Blade Flange**

#### Installing the Inner Blade Flange

1. Inspect the inner blade flange for damages and clean or replace as necessary.
2. Place the flange onto the tapered portion of the blade shaft.
3. Apply Loctite 262 (red) or an equivalent to the setscrew threads.
4. Place the setscrew into the flange's setscrew hole and tighten the screw down to the blade shaft key to secure the flange. *Note: Always make sure the flange is secure prior to operating the saw.*

#### Removing the Inner Blade Flange

1. Remove the setscrew from the back of the inner blade flange using an Allen wrench.
2. Remove the flange from the blade shaft.

### **Wheels**

#### **! WARNING**

- Raise the saw to a proper height for access when working underneath the saw. Use chocks to block the wheels, and fit blocks or jacks under the frame edges at the front and back of the frame for additional support.
- Always wear safety glasses when removing retaining rings.



#### Front Wheels

Inspect the front wheels regularly for damages or wear and replace as necessary.

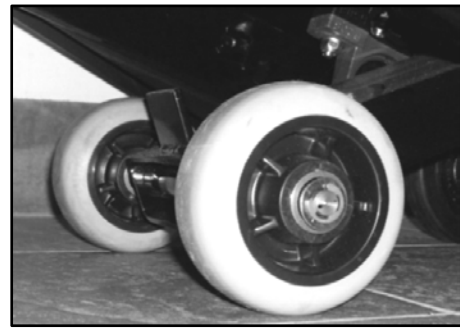
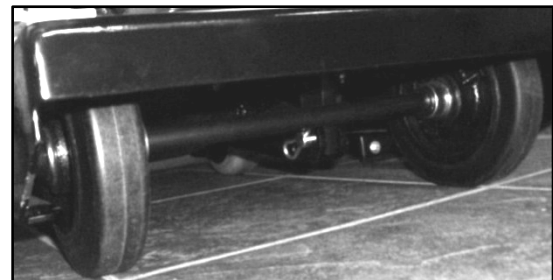

**Figure 26: Front Wheels**

1. Raise the saw to gain access to the front wheels.
2. Remove the retaining ring using retaining-ring pliers.
3. Remove the washer and wheel from the wheel shaft.
4. Place a new wheel and then the washer onto the wheel shaft.
5. Snap the retaining ring into the groove at the front of the wheel shaft to secure the wheel.
6. Repeat steps 2–5 to replace the second wheel.

#### Rear Wheels

Inspect the rear wheels regularly for damages or wear and replace as necessary.



**Figure 27: Rear Wheels**

1. Raise the saw to gain access to the bottom of the frame. There are two holes (one on each side of the saw) in the frame near the rear wheels.
2. Loosen both rear axle setscrews through these holes and then lower the saw.
3. Loosen both set collar setscrews.
4. Slide the axle to the right (you are facing the back of the axle) and remove the wheel assembly on the left.
5. Place a set collar, washer, new wheel, and another washer (in this order) onto the end of the axle. Slide the axle back into the axle hole on the left, and then push the assembly parts to the left.
6. Slide the axle to the left (you are facing the back of the axle) and remove the wheel assembly on the right.

7. Place a set collar, washer, new wheel, and another washer (in this order) onto the end of the axle. Slide the axle back into the axle hole on the right, and then push the assembly parts to the right. *Note: The axle should not protrude from either side of the frame base.*
8. Raise the saw and retighten the rear axle setscrews to secure the rear axle; lower the saw again.
9. Push the group of items from step 5 tightly up against the left side of the saw, and tighten the set collar setscrew to secure the wheel assembly.
10. Push the group of items from step 7 tightly up against the right side of the saw, and tighten the set collar setscrew to secure the wheel assembly.

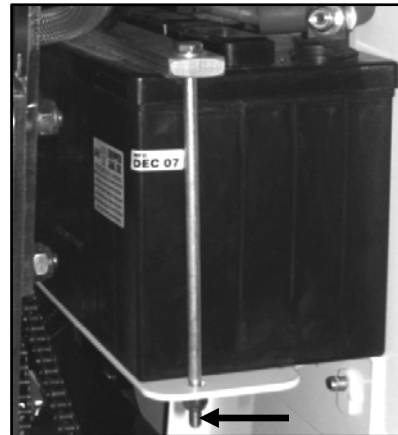

**Figure 28: Battery Support Brace**

### **Battery (Gas Model)**

#### **! WARNING**

- Ignitable explosive gases are emitted from the battery. DO NOT expose the battery to sparks or open flames.
- Disconnect the battery prior to servicing all saw components (unless stated otherwise).
- Always keep the battery cable clamps away from the battery terminals when the battery is disconnected to avoid accidental connections while servicing.



#### **! CAUTION**

- Use a proper battery tester when testing the battery strength.
- Use protective eyewear or a face shield, and avoid contact with the skin when handling/servicing the battery.

#### Battery Type

12 Volt, Group U1

#### Servicing the Battery

1. Turn off the master disconnect.
2. Remove the battery support brace nuts and the support brace.

3. Remove the negative battery boot and disconnect the negative battery cable lead from the negative battery terminal.
4. Remove the positive battery boot and disconnect the positive battery cable lead from the positive battery terminal.
5. Slide the battery off the battery platform, keeping it level.
6. When replacing the battery, place a new battery onto the battery platform, keeping it level. Bring the old battery to a recycling facility; many battery retailers also accept old batteries.
7. When cleaning the battery, inspect its terminals, clamps, and cables for damages and corrosion. Clean the terminals and clamps using a wire brush, or use another approved technique for cleaning. Use acid-free, acid-resistant grease to grease the battery clamps and terminals.
8. Reconnect the positive battery cable lead to the positive battery terminal and replace the battery boot.
9. Reconnect the negative battery cable lead to the negative battery terminal and replace the battery boot.
10. Fit the battery support brace over the battery and retighten the nuts to secure the brace.
11. Turn on the master disconnect (as necessary).

### **Electrical System**

#### **! WARNING**

- Always use the correct size fuses (amps) to prevent fires.



Check the in-line fuse (applicable models) below the control panel if the engine does not start when actuating the ignition key, and replace the fuse as necessary.

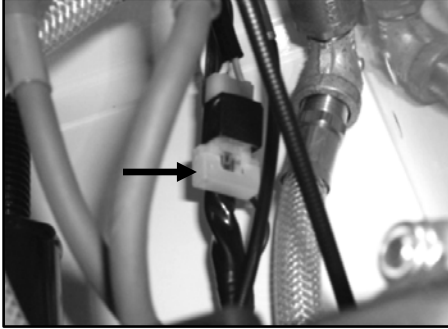

Figure 29: In-Line Fuse

### Hydraulic Ball Valve (Hydraulic Model)

#### **! WARNING**

- DO NOT disconnect hydraulic hoses from the hydraulic motor saw when the saw or the hydraulic power unit is running.
- Always place a piece of cardboard or paper up against hydraulic components, or use a leak detection fluid to check for hydraulic fluid leaks. Keep all body parts away from leaks and/or areas that may eject hydraulic fluid. Pressurized hydraulic fluid can penetrate the skin, causing serious injuries. Seek medical attention immediately!



The hydraulic ball valve assembly is on the frame's left side and can be moved to the frame's right side if preferred. *Note: When moving the ball valve to the right side of the saw, the water valve must be removed and secured to the left side.*

#### Disconnecting the Hydraulic Ball Valve

*Note: Place an oil drain tray underneath any hose connection points for possible oil drainage.*

1. Disconnect the pipe adapter from the steel pressure line fitting. DO NOT disconnect the pipe adapter from the quick disconnect.
2. Disconnect the pipe adapter from the steel return line fitting. DO NOT disconnect the pipe adapter from the quick disconnect.
3. Disconnect the pressure line hose from the pipe tee at the top of the hydraulic ball valve.
4. Disconnect the return line hose from the pipe tee at the bottom of the hydraulic ball valve.
5. Remove the U-bolts, valve assembly, and shim plate from the frame upright.

#### Connecting the Hydraulic Ball Valve

1. Rotate the pressure line pipe tee 180°.
2. Rotate the return line pipe tee 180°.
3. Secure the shim plate and valve assembly to the opposite side of the saw using the U-bolts and nuts.
4. Fit the steel pressure line into the upper plug hole below the handlebar shaft, and fit the steel return line into the lower plug hole below the handlebar shaft.
5. Connect the pressure line hose to the pipe tee at the top of the valve.
6. Connect the return line hose to the pipe tee at the bottom of the valve.
7. Connect the pipe adapter for the pressure line to the steel pressure line fitting.
8. Connect the pipe adapter for the return line to the steel return line fitting.

### Speed Control Lever

When the speed control lever (self-propelled model) is out of sync with the saw; for example, if the saw moves forward when the lever is at *Neutral* adjustments are needed.

#### Adjusting the Speed Control Lever

1. Start the engine and engage the transmission.
2. Adjust the speed control lever until the saw stops moving completely. This is the current neutral position. DO NOT move the speed control lever any further.
3. Disengage the transmission and turn off the engine.
4. Loosen the pivot pin setscrew near the transmission.

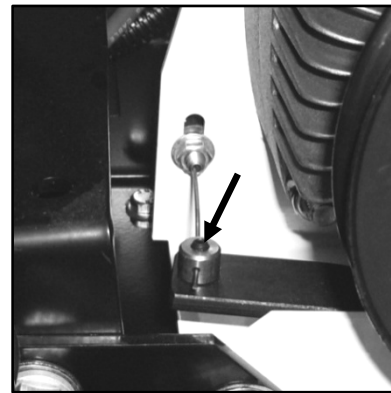

Figure 30: Pivot Pin and Setscrew

5. Move the speed control lever to *Neutral*.
6. Retighten the pivot pin setscrew to secure the new neutral position. Turn on the engine to test the movement and adjust as necessary.

## Transmission

Regularly wipe down the transmission (self-propelled model) to help prevent high oil temperatures.

### Adding Transmission Oil

Check the transmission oil level daily/regularly.

1. Remove the transmission oil reservoir cap.

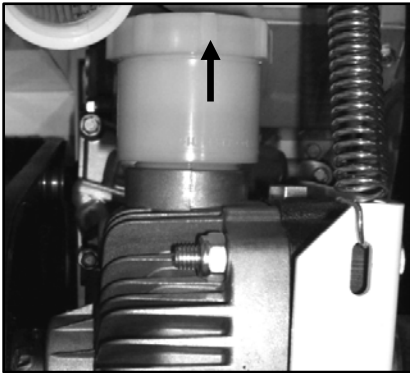

Figure 31: Oil Reservoir Cap

2. Add Mobil ATF D/M oil or an equivalent up to the *Oil Level Cold* line as necessary.
3. Replace the oil reservoir cap and tighten to secure.

### Adjusting the Drive Wheels

The drive wheels should fully engage the rear wheels when the transmission is engaged. Check the engagement pressure daily/regularly to avoid wheel slippage.

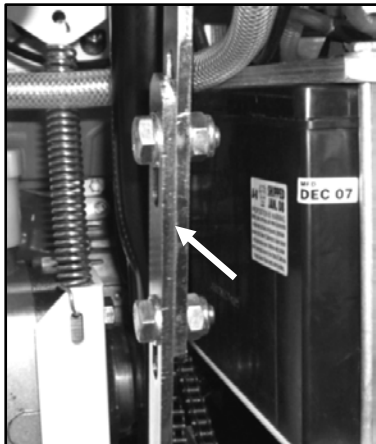

Figure 32: Engagement Linkage

1. Loosen the engagement linkage nuts.
2. Move the lower engagement linkage downward so the drive wheels fully engage the rear wheels.

3. Retighten the nuts to secure the engagement linkage.
4. Engage the transmission to make sure the drive wheels fully engage the rear wheels. Readjust the engagement linkage as necessary.

### Adjusting the Rear Drive Chain

Regularly inspect the rear drive chain and tighten as necessary. Regularly lubricate the rear drive chain with oil to increase chain life.

1. The transmission is secured to the transmission platform with four screws and nuts. Loosen the nut on each screw.

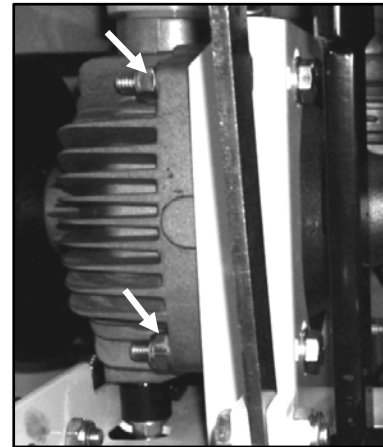

Figure 33: Transmission Nuts

2. Push the transmission up in the transmission platform slots to tighten the chain. Leave a little bit of slack in the chain and DO NOT over-tighten it.
3. Retighten all four nuts to secure the transmission to the platform.

## Belts

### **WARNING**

- Turn off the engine/motor prior to servicing the belts.



### **CAUTION**

- Always let the belts cool down prior to servicing them.

*Note: Over-tensioning the belts may damage the engine crankshaft. Under-tensioning the belts may cause shorter belt life and/or poor saw performance. Squealing belts indicate looseness.*

## Tensioning the Blade Drive Belts

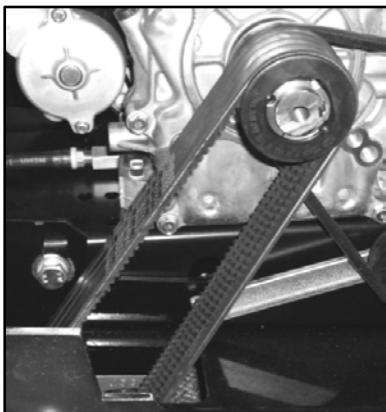

**Figure 34: Blade Drive Belts**

1. Inspect the belts for fraying, stress cracks, and/or breakage and replace immediately when damaged.
2. Test the belt tension. Proceed to step 3 if the belts need tensioning (refer to Appendix C for the proper tension setting). Operate the saw as needed if no tension adjustments are required.
3. There are four engine/motor base screws; two on the side of both bases. Loosen the nut on each screw.

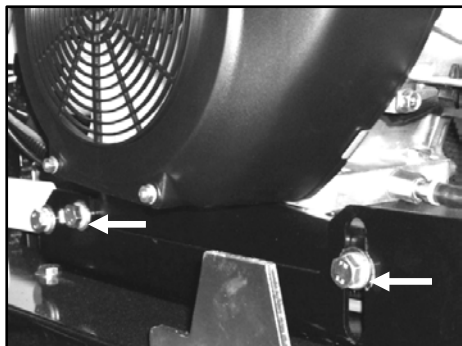

**Figure 35: Engine/Motor Base Screws**

4. Turn the tension bolt at the front of the engine/motor clockwise to tighten the belts. Readjust the tension bolt as necessary to reach the required tension setting. DO NOT exceed the manufacturer's tension setting.

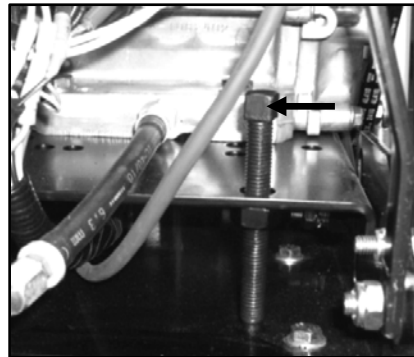

**Figure 36: Tension Bolt**

5. Retighten all four engine/motor base nuts.

## Replacing the Blade Drive Belts

1. There are four engine/motor base screws; two on the side of both bases. Loosen the nut on each screw.
2. Turn the tension bolt at the front of the engine/motor counterclockwise to loosen the belts. DO NOT remove the bolt.
3. Remove the belts from the crankshaft sheave and from the blade shaft sheave.
4. Loop and align the new belts around the blade shaft sheave, and then pull them up and loop and align them around the crankshaft sheave.
5. Turn the tension bolt at the front of the engine/motor clockwise to tighten the belts (refer to Appendix C for the proper tension setting). Readjust the tension bolt as necessary to reach the required tension setting. DO NOT exceed the manufacturer's tension setting.
6. Retighten all four engine/motor base nuts.

## Replacing the Transmission V-Belt

Inspect the V-belt regularly for fraying, stress cracks, and breakage, and replace immediately when damaged.

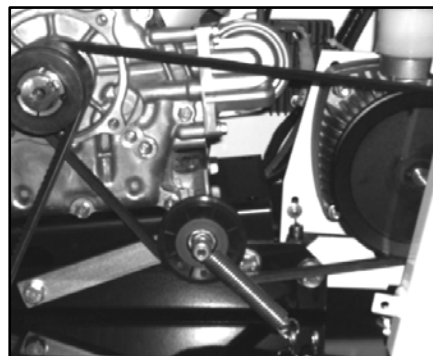

**Figure 37: Transmission V-Belt**

1. Remove the blade drive belts from the crankshaft sheave.
2. Remove the nut and spring from the front of the idler pulley.
3. Lift the idler pulley up and remove the V-belt from the idler pulley.
4. Release the idler pulley and remove the V-belt from the transmission pulley and from the accessory drive pulley.
5. Loop the new V-belt around the accessory drive pulley.
6. Loop the upper V-belt section around the transmission pulley, and then wrap the lower V-belt section under the idler pulley.
7. Place the spring and then the nut back onto the idler pulley screw and tighten the nut to secure the assembly. *Note: Secure the other end of the idler pulley spring to the second cotter pin on the frame base to provide more tension as the belt stretches during use. Replace the belt when moving the spring to the second cotter pin does not provide enough tension.*
8. Retighten the blade drive belts.

## Engine/Motor

<p><b>! WARNING</b></p> <ul style="list-style-type: none"> <li>• Let the engine/motor cool down prior to servicing the saw.</li> <li>• DO NOT service the saw with the engine/motor running (unless stated otherwise).</li> </ul>	
---	---

Refer to the engine/motor manual and manufacturer for a full maintenance schedule and additional maintenance information.

### Cleaning the Engine/Motor

Wipe down the engine's/motor's exterior and guards daily or regularly to prevent high operating temperatures. DO NOT spray the engine/motor with water to prevent engine/motor damage.

### **Fuel Filter (GX620 Honda)**

#### Replacing the Fuel Filter

Replace the secondary fuel filter every 125 hours.

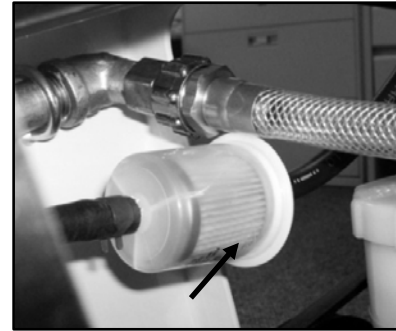

**Figure 38: Secondary Fuel Filter**

1. Lower the saw so the engine is level.
2. Close the fuel shutoff valve.
3. Hold/place a tray below the hoses and filter.
4. Remove the spring clamps, one on each side of the fuel filter, from the hoses using an appropriate tool.
5. Remove the fuel filter. Dispose of the used fuel and filter according to city, state, and federal regulations.
6. Point the arrow on the new fuel filter toward the engine.
7. Place the fuel hose coming from the fuel shutoff valve onto the end of the filter (the arrow on the filter should not point toward this hose). Push the hose tightly up against the edge of the filter.
8. Fit one spring clamp next to the filter to secure the hose.
9. Place the fuel hose coming from the engine onto the other end of the filter (the arrow on the filter should point toward this hose). Push the hose tightly up against the edge of the filter.
10. Fit one spring clamp next to the filter to secure the hose.
11. Open the fuel shutoff valve and check for leaks.

## Storing

Complete the tasks listed below prior to storing the saw for longer time frames:

- Lower the saw completely to remove any strain on the lifting mechanism.
- Turn off all switches and controls (including the master disconnect).
- Remove the battery from the saw and store it in a proper location, out of reach from children.
- Disconnect the water supply hose from the blade guard, open the water valve, and blow compressed air through the water supply fitting to drain water from the water lines/hoses.
- Clean the blade guard water tubes using a wire brush and rinse with a hose.
- Clean and wipe down the saw.



- Store the saw in a cool, dry area out of reach from children.
- Refer to the engine/motor manual for engine/motor tasks prior to storing the saw.

### ***Disposal***

Properly dispose of the saw when it's no longer repairable, and/or contains safety hazards not worth repairing or maintaining. Complete the tasks listed below to properly dispose of the saw when discontinuing usage:

- Drain all fluids from the saw and dispose according to city, state, and federal regulations.
- Remove the battery from the saw and bring it to a recycling facility; many battery retailers also accept old batteries.
- Secure the saw in a truck/trailer and transport it to a salvage yard or recycling facility for appropriate disposal.

# References

## **Appendix A**

### Serial Tags

Record the saw's serial number below for future reference and customer service purposes.

Serial Number	
---------------	--

Record the engine's/motor's model and serial numbers below for future reference and customer service purposes.

Model Number	
Serial Number	

## Appendix B

### Daily Maintenance Task Chart

Table 6: Daily Maintenance Task Chart							
Date							
		✓	✓	✓	✓	✓	✓
1.	Lubricate blade shaft bearing grease fittings daily or two to three times daily when dry cutting.						
2.	Inspect belts after first four hours of use, and then daily for tension and wear. Replace or re-tension as necessary.						
3.	Inspect saw for damages.						
4.	Tighten loose nuts and bolts.						
5.	Verify that drive wheels fully engage rear wheels when transmission is engaged (self-propelled model).						
6.	Clean air filter daily or two to three times daily when dry cutting (see engine manual).						
7.	Check fuel level and fill as necessary.						
8.	Check engine oil level and fill as necessary (see engine manual).						
9.	Wipe down saw's exterior.						
10.	Wipe down engine's/motor's exterior and guards.						
11.	Look for fluid leaks.						
12.	Re-tension rear drive chain as necessary (self-propelled model).						
<i>Refer to engine/motor manual for daily engine/motor maintenance tasks.</i>							

## Appendix C

### Belt Tension Settings

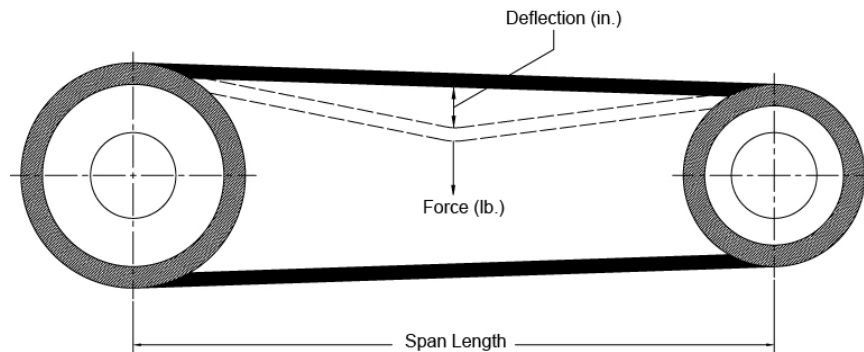

Deflection (in.) should be equal to number of inches listed in chart below when force (lb.) listed in chart below is applied to belt using tension gauge.

**Table 7: Push Saw Belt Tension Settings**

Model Number	Engine/Motor Type	Belt	Tension Setting
CC1875E1 XL-P CC1810E3 XL-P	7.5HP Baldor Electric 1 PH-230V 10HP Baldor Electric 3 PH	3VX375	0.23 in. at 5.7 lb Force
CC1813H XL-P	11HP Honda GX390	3VX335	0.20 in. at 5.7 lb Force
CC1816BV XL-P CC1818HY XL-P	16HP Briggs Vanguard 18HP Danfoss Hydraulic	3VX355 3VX375	0.21 in. at 5.7 lb Force

**Table 8: Self-Propelled Saw Belt Tension Settings**

Model Number	Engine/Motor Type	Belt	Tension Setting
CC1875E1 XL-S CC1810E3 XL-S	7.5HP Baldor Electric 1 PH-230V 10HP Baldor Electric 3 PH	3VX375	0.23 in. at 5.7 lb Force
CC1813H XL-S	11HP Honda GX390	3VX335	0.20 in. at 5.7 lb Force
CC1816BV XL-S CC1818HY XL-S CC1820H XL-S	16HP Briggs Vanguard 18HP Danfoss Hydraulic 18HP Honda GX620	3VX355 3VX375 3VX355	0.21 in. at 5.7 lb Force

## Appendix D

### Troubleshooting

<b>Table 9: CC1800XL Troubleshooting</b>		
<b>Symptom</b>	<b>Problem</b>	<b>Solution</b>
1. Saw will not raise.	Index plunger in?	Pull index plunger out to move handwheel.
2. Saw will not lower.	Index plunger in?	Pull index plunger out to move handwheel.
3. Blade does not cut straight.	Excessive force applied while sawing?	Reduce forward speed.
	Wrong blade for application?	Contact dealer/manufacturer of blade.
4. Short belt life.	Loose belts causing slippage?	Check belt tension regularly.
	Sheaves misaligned?	Use straightedge to check blade shaft sheave alignment.
	Worn sheave grooves?	Check for groove wear and replace as necessary.
	Mismatched belt set?	Replace with new set of matched belts. DO NOT mix old and new belts.
	Overheating of belts?	Check belt tension.
5. Engine/motor does not start. (Refer to the engine/motor manual and manufacturer for additional engine/motor troubleshooting information.)	Emergency stop button down?	Pull out emergency stop button.
	Master disconnect off?	Turn on master disconnect.

## Appendix E

### Additional Resources

1. Diamond Products ([www.diamondproducts.com](http://www.diamondproducts.com))
  - *CC1800XL Concrete Saw Parts List; Ohio, 2007*
  - *CC1800XL Concrete Saw Parts List–Electric & Hydraulic Units; Ohio, 2007*
  - *A Guide for Professional Concrete Cutters*
  - *Training Manual–Introduction to Diamond Blades, Bits, and Equipment*
  - *Diamond Products' Equipment Catalog*
  - *Diamond Products' Website ([www.diamondproducts.com](http://www.diamondproducts.com))*
2. Honda Motor Company ([www.honda-engines.com](http://www.honda-engines.com))
  - *Owner's Manual; GX610, GX620, GX670; Japan, 2007*
  - *Owner's Manual; GX240, GX270, GX340, GX390; Japan, 2007*
3. Briggs & Stratton Corporation ([www.briggsandstratton.com](http://www.briggsandstratton.com))
  - *Operator's Manual; 290000, 300000, 350000, 380000; Wisconsin*
4. Baldor Electric Company ([www.baldor.com](http://www.baldor.com))
  - *Installation and Operating Manual; MN400; Arkansas, 2007*
5. Sauer-Danfoss ([www.sauer-danfoss.com](http://www.sauer-danfoss.com))
6. Concrete Sawing and Drilling Association (CSDA) ([www.csda.org](http://www.csda.org))
  - *The CSDA has many helpful concrete cutting publications available to members and non-members.*
7. Association of Equipment Manufacturers (AEM) ([www.aem.org](http://www.aem.org))
  - *The AEM has a variety of safety and technical manuals available for various types of equipment, along with a list of industry-standardized safety symbols.*
8. Occupational Safety and Health Administration (OSHA) ([www.osha.gov](http://www.osha.gov))
  - *OSHA provides information on work-related safety and health practices.*
9. The National Institute for Occupational Safety and Health (NIOSH) ([www.cdc.gov/NIOSH](http://www.cdc.gov/NIOSH))
  - *NIOSH provides information on work-related safety and health practices.*

